

Compact cylinder to ISO 21287, LINER series, available in different versions to meet all possible requirements:

- With or without magnet
- Double acting, single or through piston rod
- Double acting, perforated through piston rod
- Single acting, extended, retracted or through piston rod
- Single acting, perforated through rod
- Double acting anti-rotating version and double acting through piston rod
- Polyurethane or FKM/FPM gaskets (for high temperatures) also available
- Dimensions and centre distances to ISO 21287.

The heads have been eliminated for ease of installation, improved sturdiness and precision. The metal lining is designed to withstand heavy-duty work, tensile stress and impact. Technopolymer parts can withstand dynamic and pneumatic thrust. The lining virtually acts as a "bearing" to which most of user accessories are attached.

The wide range of anchors provide numerous fixing points.

Retractable magnetic limit switches can be mounted to identify the position in the cylinder grooves.



7.DMI.320080

7.DMA.320080

TECHNICAL DATA		POLYURETHANE				FKM/FPM			
Max operating pressure	bar					10			
	MPa					1			
Temperature range	psi					145			
	°C	-10 to +60 (Ø 20 to 63) -10 to +80 (Ø 80 to 100)				-10 to +150 (non-magnetic cylinders)			
Fluid		Unlubricated air. Lubrication, if used, must be continuous.							
Bores	mm	20; 25; 32; 40; 50; 63; 80; 100 with ISO 21287 fixing centre distances							
Design		With profile							
Versions		Double-acting, Double-acting through-rod, Single-acting extended or retracted rod, Single-acting through-rod, Double-acting through-rod perforated, Double-acting non-rotating, Double-acting through-rod non-rotating, No stick slip							
		All versions are available with male or female piston rod.							
Magnet for sensors		All versions come complete with magnet. Supplied without magnet on request.							
Inrush pressure	bar	Ø 20	Ø 25	Ø 32	Ø 40	Ø 50	Ø 63	Ø 80	Ø 100
		0.6	0.6	0.6	0.4	0.4	0.4	0.4	0.4
Forces generated at 6 bar thrust/retraction	bar	0.8	0.8	0.6	0.4	0.4	0.4	0.4	0.4
Weights		see page 1-7							
Notes		see page 1-9							
		For correct operation, it is advisable to use 50 µm filtered air							
		For speeds lower than 0.2 m/s to prevent surging, use the version No stick-slip and non-lubricated air.							
Piston Material		Ø 20 to 63 = POM, Ø 80 to 100 = aluminium							

COMPONENTS Ø 20-25

- ① PISTON ROD: stainless steel, thick chromed
- ② END CAP: high-performance technopolymer
- ③ BARREL: drawn anodised and calibrated aluminium alloy
- ④ PISTON GASKET: polyurethane or FKM/FPM (for high temperature)
- ⑤ MAGNET: plastoneodimio
- ⑥ PISTON ROD GASKET: polyurethane or FKM/FPM (for high temperature)
- ⑦ GUIDE BUSHING: sintered bronze
- ⑧ STATIC O-RINGS: NBR or FKM/FPM (for high temperature)

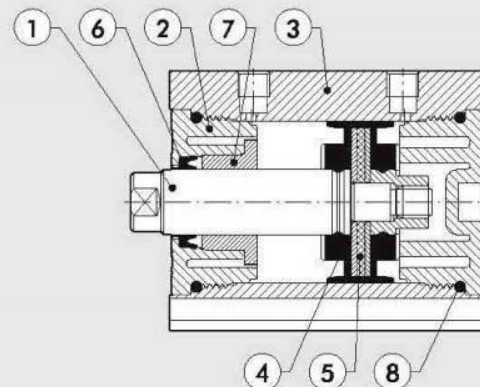

Compact cylinders LINER

Acc.to ISO 21287 \varnothing 20 to 100
 Type No. 7.DMI.20005 to 7.DMI.100080
 Type No. 7.DMA.20005 to 7.DMA.100080

COMPONENTS \varnothing 32-63

- ① PISTON ROD: C45 steel or stainless steel, thick chromed
- ② END CAP: high-performance technopolymer
- ③ BARREL: drawn anodised and calibrated aluminium alloy
- ④ PISTON GASKET: polyurethane or FKM/FPM (for high temperature)
- ⑤ MAGNET: \varnothing 32 plastoneodimio - \varnothing 40 to 63 plastoferrite
- ⑥ PISTON ROD GASKET: polyurethane or FKM/FPM (for high temperature)
- ⑦ GUIDE BUSHING: sintered bronze
- ⑧ STATIC O-RINGS: NBR or FKM/FPM (for high temperature)

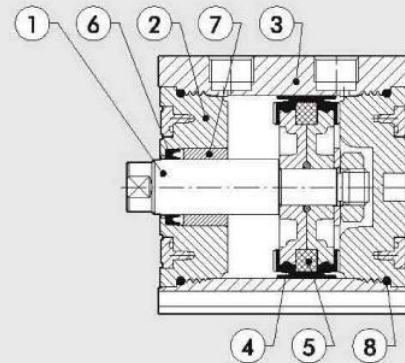
COMPONENTS \varnothing 80-100

- ① PISTON ROD: C45 steel or stainless steel, thick chromed
- ② END CAP: anodized aluminium alloy
- ③ BARREL: drawn anodised and calibrated aluminium alloy
- ④ PISTON GASKET: polyurethane or FKM/FPM (for high temperature)
- ⑤ MAGNET: plastoferrite
- ⑥ PISTON ROD GASKET: polyurethane or FKM/FPM (for high temperature)
- ⑦ GUIDE BUSHING: steel strip with bronze and PTFE insert
- ⑧ STATIC O-RINGS: NBR or FKM/FPM (for high temperature)

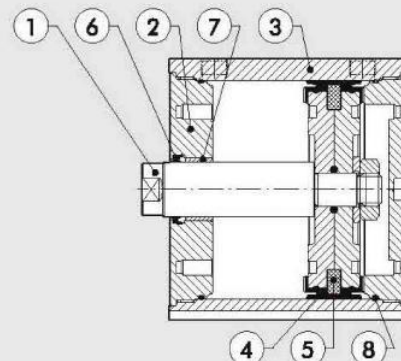

FIXING OPTIONS

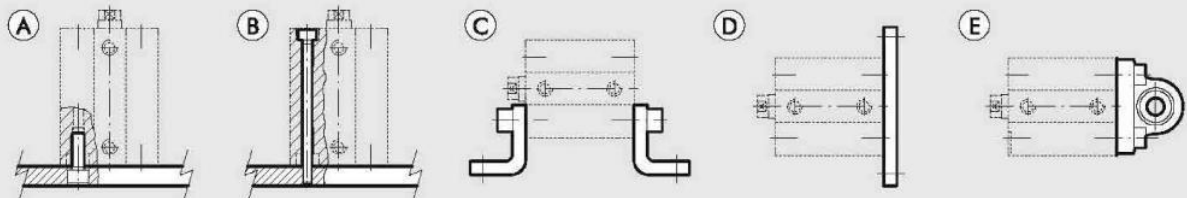

- A Fixing to structural work with a through screw, using the thread in the heads
- B Direct fixing from above using long through screws or tie rods. Non-magnetic stainless steel must be used (e.g. AISI 304)
- C Fixing with feet; the ordering code covers the supply of one foot and two screws for fixing to the cylinder
- D Fixing with a flange mounted on the front or rear head; the ordering code covers the supply of a flange and four screws for fixing to the cylinder
- E Fixing with articulated hinge to compensate for slight system misalignment and turn freely
The ordering code covers the supply of a hinge and four screws for fixing to the cylinder.

FORCE OF SPRINGS IN SINGLE-ACTING CYLINDERS (THEORETICAL)

Bore	\varnothing 20	\varnothing 25	\varnothing 32	\varnothing 40	\varnothing 50	\varnothing 63	\varnothing 80	\varnothing 100
Min. load (N)	8.40	13.90	19.00	24.80	36.30	50.20	77.60	131.80
Max. load (N)	20.90	33.20	35.90	53.70	62.20	82.30	118.90	183.30

STROKES FOR COMPACT CYLINDERS ISO 21287

Standard stroke for single-acting cylinders	Standard stroke for other types	Max. recommended strokes for other types	Max. recommended strokes for non-rotating cylinders	Max recommended strokes for through-rod perforated
\varnothing 20 to 100 \rightarrow 25 mm	\varnothing 20 to 25 \rightarrow 5 to 60 mm \varnothing 32 to 100 \rightarrow 5 to 80 mm	\varnothing 20 to 25 \rightarrow 300 mm \varnothing 32 to 63 \rightarrow 400 mm \varnothing 80 to 100 \rightarrow 500 mm	\varnothing 20 to 63 \rightarrow 120 mm \varnothing 80 to 100 \rightarrow 150 mm	\varnothing 20 to 40 \rightarrow 5 to 80 mm \varnothing 50 to 63 \rightarrow 5 to 100 mm \varnothing 80 to 100 \rightarrow 5 to 160 mm

Maximum recommended strokes. Higher values can create operating problems

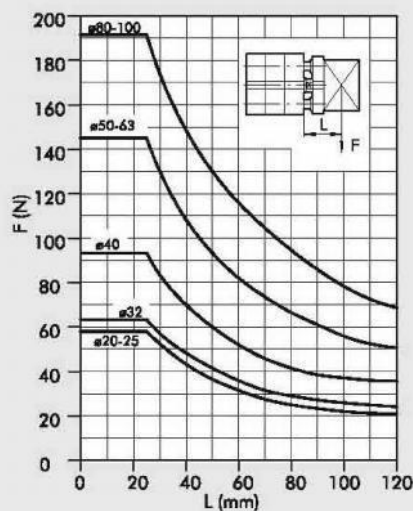
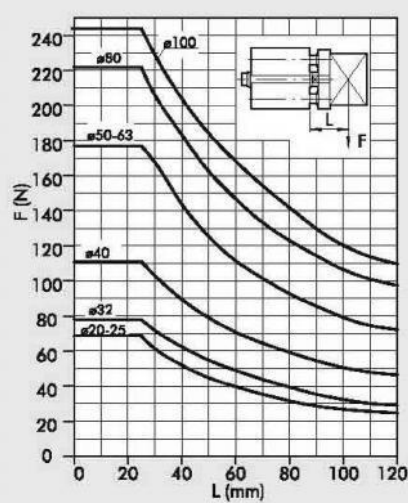
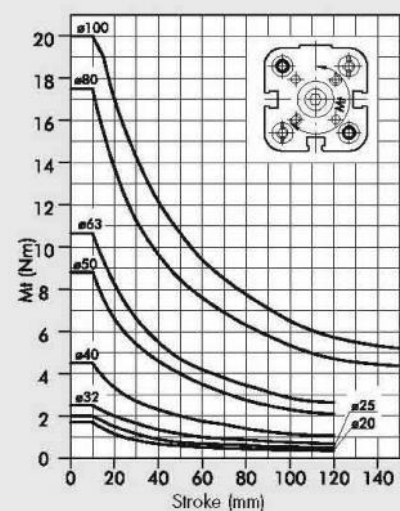
MAXIMUM LOADS FOR NON-ROTATING VERSION
TRANSVERSAL FORCE FOR NON-ROTATING

TRANSVERSAL FORCE FOR NON-ROTATING THROUGH-ROD

TORQUE DEPENDING ON STROKE

Compact cylinders LINER

Acc.to ISO 21287 Ø 20 to 100
 Type No. 7.DMI.20005 to 7.DMI.100080
 Type No. 7.DMA.20005 to 7.DMA.100080



DIMENSIONS OF DOUBLE-ACTING Ø 20 to 50 AND SINGLE-ACTING Ø 20 to 50

SE-DE MALE PISTON ROD

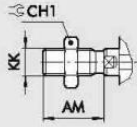

- + = ADD THE STROKE
- * = SECTION WITH TOLERANCE
- 1 = SENSOR SLOT
- 2 = SEAT FOR DIN 7984 SCREWS

SE EXTENDED PISTON ROD

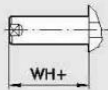

SE MALE EXTENDED PISTON ROD

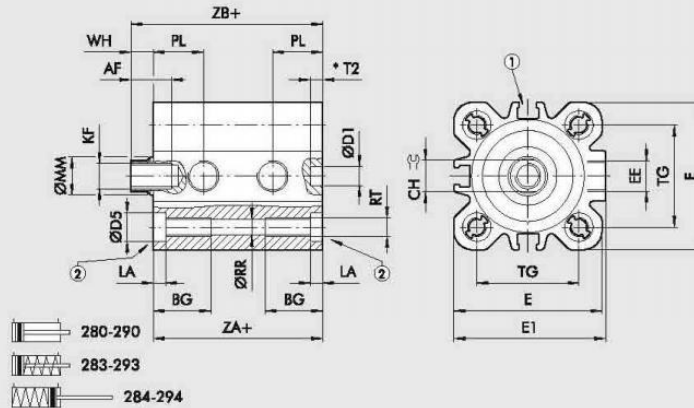
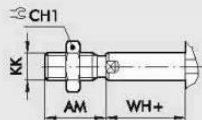

Ø	AF	AM	BG	CH	CH1	ØD1 ¹⁰	ØD5	E	E1	EE	KF	KK	LA	ØMM	PL	ØRR	RT	T2	TG ^{0.2}	WH	ZA ^{0.3}	ZB
20	14	16	17.5	8	13	6	7.5	35.5	36.5	M5	M6	M8	4.2	10	12	4.2	M5	3	22	6	37	43
25	14	16	17.5	8	13	6	7.5	39.5	40	M5	M6	M8	4.2	10	13	4.2	M5	3.5	26	6	39	45
32	16.5	19	21.5	10	17	6	9	47	48.2	G1/8	M8	M10x1.25	4	12	16	5.1	M6	4	32.5	7	44	51
40	16.5	19	21.5	10	17	6	9	55.5	56.5	G1/8	M8	M10x1.25	4	12	16	5.1	M6	4	38	7	45	52
50	17	22	21	13	19	6	10.5	66.5	67.8	G1/8	M10	M12x1.25	4.5	16	15.5	6.8	M8	3	46.5	8	45	53

DIMENSIONS OF DOUBLE-ACTING Ø 63 to 100 AND SINGLE-ACTING Ø 63 to 100

SE-DE MALE PISTON ROD

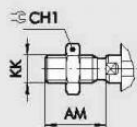

- + = ADD THE STROKE
- * = SECTION WITH TOLERANCE
- 1 = SENSOR SLOT
- 2 = SEAT FOR DIN 7984 SCREWS

SE EXTENDED PISTON ROD

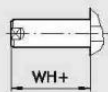

SE MALE EXTENDED PISTON ROD

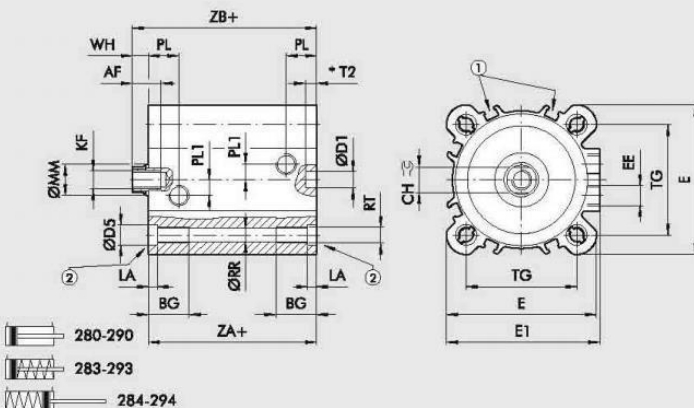
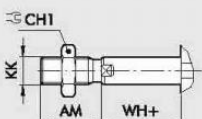

Ø	AF	AM	BG	CH	CH1	ØD1 ¹⁰	ØD5	E	E1	EE	KF	KK	LA	ØMM	PL1	PL	ØRR	RT	T2	TG ^{0.2}	WH	ZA ^{0.4}	ZB
63	17	22	21	13	19	8	10.5	76.5	78.3	G1/8	M10	M12x1.25	4.5	16	8	15.5	6.8	M8	3.5	56.5	8	49	57
80	22	28	22.5	17	24	8	14	95.5	95.5	G1/8	M12	M16x1.5	5	20	14	16.5	8.5	M10	4	72	10	54	64
100	24	28	25.5	22	30	8	14	114	114	G1/8	M12	M16x1.5	5	25	19	19.2	8.5	M10	4	89	10	67	77

DIMENSIONS OF THROUGH-ROD \varnothing 20 to 50

SE-DE MALE PERFORATED THROUGH-ROD

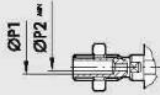

- + = ADD THE STROKE
- ++ = ADD TWICE THE STROKE
- 1 = SENSOR SLOT
- 2 = SEAT FOR DIN 7984 SCREWS

SE-DE MALE PISTON ROD

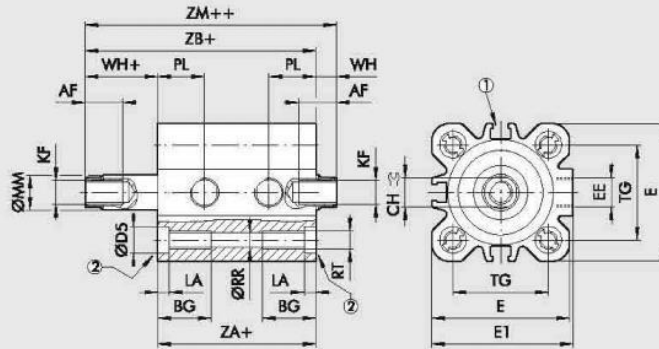
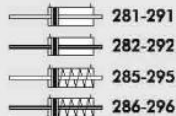
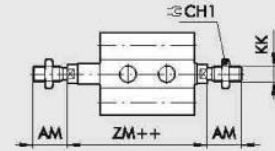

Ø	AF	AM	BG	CH	CH1	ØD5	E	E1	EE	KF	KK	LA	ØMM	ØP1	ØP2	PL	ØRR	RT	TG ^{0,2}	WH	ZA ^{0,3}	ZB	ZM
20	14	16	17.5	8	13	7.5	35.5	36.5	M5	M6	M8	4.2	10	3	1.5	12	4.2	M5	22	6	37	43	49
25	14	16	17.5	8	13	7.5	39.5	40	M5	M6	M8	4.2	10	3	1.5	13	4.2	M5	26	6	39	45	51
32	16.5	19	21.5	10	17	9	47	48.2	G1/8	M8	M10x1.25	4	12	4	2.5	16	5.1	M6	32.5	7	44	51	58
40	16.5	19	21.5	10	17	9	55.5	56.5	G1/8	M8	M10x1.25	4	12	4	2.5	16	5.1	M6	38	7	45	52	59
50	17	22	21	13	19	10.5	66.5	67.8	G1/8	M10	M12x1.25	4.5	16	6	4	15.5	6.8	M8	46.5	8	45	53	61

DIMENSIONS OF THROUGH-ROD \varnothing 63 to 100

SE-DE MALE PERFORATED THROUGH-ROD

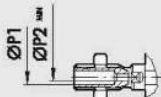

- + = ADD THE STROKE
- ++ = ADD TWICE THE STROKE
- 1 = SENSOR SLOT
- 2 = SEAT FOR DIN 7984 SCREWS

SE-DE MALE PISTON ROD

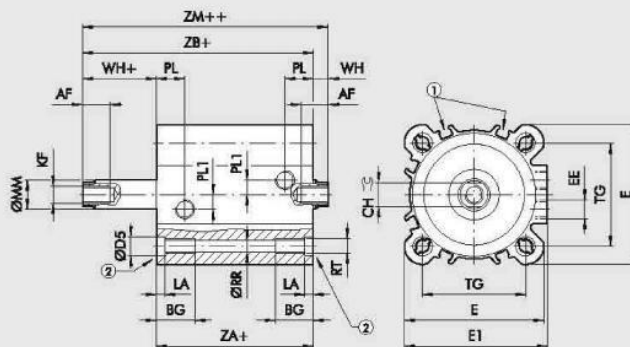
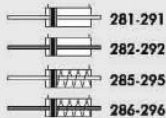
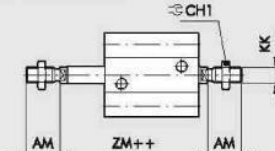

Ø	AF	AM	BG	CH	CH1	ØD5	E	E1	EE	KF	KK	LA	ØMM	ØP1	ØP2	PL1	PL	ØRR	RT	TG ^{0,2}	WH	ZA ^{0,4}	ZB	ZM
63	17	22	21	13	19	10.5	76.5	78.3	G1/8	M10	M12x1.25	4.5	16	6	4	8	15.5	6.8	M8	56.5	8	49	57	65
80	22	28	22.5	17	24	14	95.5	95.5	G1/8	M12	M16x1.5	5	20	G1/8	5	14	16.5	8.5	M10	72	10	54	64	74
100	24	28	25.5	22	30	14	114	114	G1/8	M12	M16x1.5	5	25	G1/8	6	19	19.2	8.5	M10	89	10	67	77	87

Compact cylinders LINER

Acc.to ISO 21287 \varnothing 20 to 100
 Type No. 7.DMI.20005 to 7.DMI.100080
 Type No. 7.DMA.20005 to 7.DMA.100080



DIMENSIONS OF NON-ROTATING \varnothing 20 to 50

- + = ADD THE STROKE
- * = SECTION WITH TOLERANCE
- 1 = SENSOR SLOT
- 2 = SEAT FOR DIN 7984 SCREWS

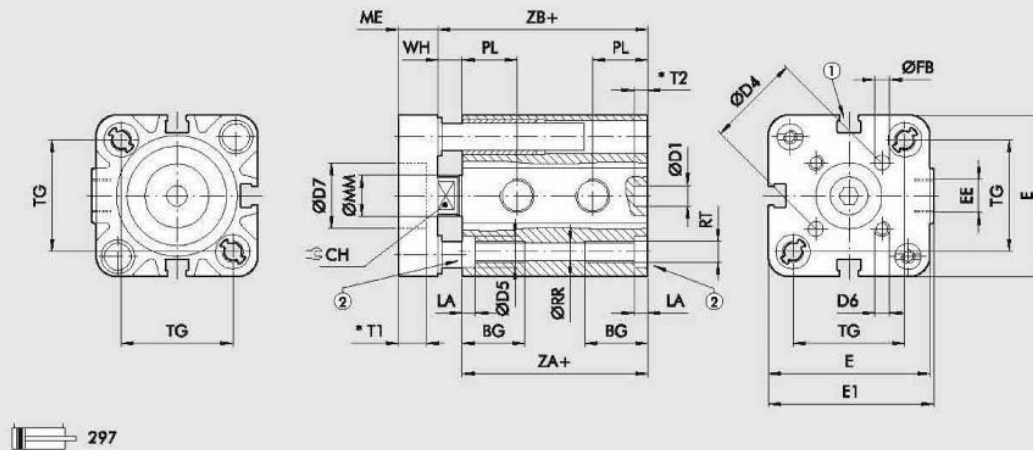

NON-ROTATING FEMALE THROUGH-ROD

- + = ADD THE STROKE
- ++ = ADD TWICE THE STROKE

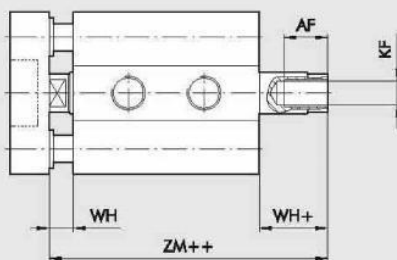

29A

NON-ROTATING MALE THROUGH-ROD

- + = ADD THE STROKE
- ++ = ADD TWICE THE STROKE

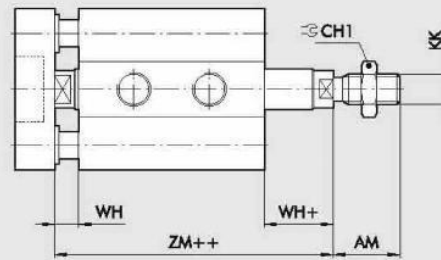

28A

\varnothing	AF	AM	BG	CH	CH1 ¹⁾	\varnothing D1 ¹⁾	\varnothing D4	\varnothing D5	D6	\varnothing D7 ¹⁾	E	E1	EE	\varnothing FB	KF	KK	LA	ME	\varnothing MM	PL	\varnothing RR	RT	T1	T2	TG ²⁾	WH	ZA ³⁾	ZB	ZM
20	14	16	17.5	8	13	6	17	7.5	M4	-	35.5	36.5	M5	4	M6	M8	4.2	8	10	12	4.2	M5	-	3	22	6	37	43	49
25	14	16	17.5	8	13	6	22	7.5	M5	14	39.5	40	M5	5	M6	M8	4.2	8	10	13	4.2	M5	3.5	3.5	26	6	39	45	51
32	16.5	19	21.5	10	17	6	28	9	M5	17	47	48.2	G1/8	5	M8	M10x1.25	4	10	12	16	5.1	M6	3.5	4	32.5	7	44	51	58
40	16.5	19	21.5	10	17	6	33	9	M5	17	55.5	56.5	G1/8	5	M8	M10x1.25	4	10	12	16	5.1	M6	3.5	4	38	7	45	52	59
50	17	22	21	13	19	6	42	10.5	M6	22	66.5	67.8	G1/8	6	M10	M12x1.25	4.5	12	16	15.5	6.8	M8	5	3	46.5	8	45	53	61

FOOT - MODEL A

+ = ADD THE STROKE

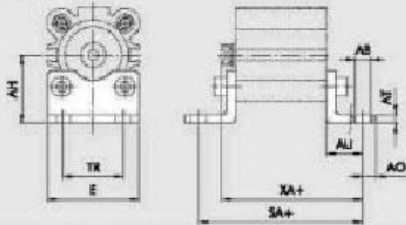
Material steel

	\varnothing	\varnothing AB	AH	AO	AT	AU	E	SA	TR	XA	Weight [g]
437.09-M	20	6.6	27	6	4	16	36	89	22	59	46
437.10-M	25	6.6	30*	6	4	16	40	71	26	61	52
437.14-M	32	7	32*	11*	4	24*	45	92*	32	75*	76
450.12-M	40	9	36*	15*	4	28*	52	101*	36	80*	100
450.13-M	50	9	45	15*	5	32*	65	109*	45	85*	162
450.14-M	63	9	50	15*	5	32*	75	113*	50	89*	266
450.15-M	80	12	63	20*	6	41*	95	136*	63	105*	456
450.16-M	100	14	71*	25*	6	41*	115	149*	75	118*	572

Note: Individually packed with 2 screws

* IMPORTANT: Values not to ISO 21287. Cylinder pins to ISO 15552 are used.

FEMALE HINGE-MODEL B

+ = ADD THE STROKE

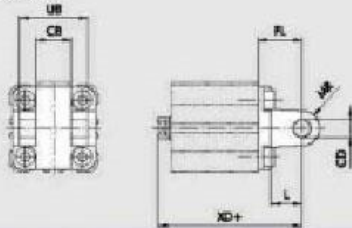

	\varnothing	CB ^{***}	\varnothing CD ^{***}	FL	L	MR	UB ^{***}	XD	Weight [g]
437.84-M	32	26	10	22	12	10	45	73	112
437.85-M	40	28	12	25	15	12	52	77	159
437.86-M	50	32	12	27	15	12	60	80	250
437.87-M	63	40	16	32	20	16	70	89	390
437.88-M	80	50	16	36	20	16	90	100	668
450.36-M	100	60	20	41	25	20	110	118	1047

Note: Supplied with 4 screws, 2 snap-rings and 1 pin

MALE HINGE-MODEL BA

+ = ADD THE STROKE

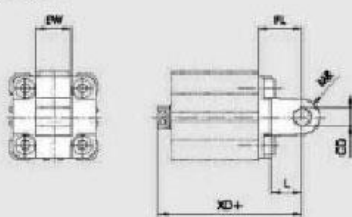

	\varnothing	\varnothing CD ^{***}	EW	FL	L	MR	XD	Weight [g]
437.72-M	20	8	16	20	14	8	63	44
437.73-M	25	8	16	20	14	8	65	48
450.71-M	32	10	26	22	12	11	73	94
450.72-M	40	12	28	25	15	13	77	124
450.73-M	50	12	32	27	15	13	80	220
450.74-M	63	16	40	32	20	17	89	316
450.75-M	80	16	50	36	20	17	100	578
450.76-M	100	20	60	41	25	21	118	850

Note: Supplied with 4 screws

FLANGE \varnothing 20 to 25 - MODEL C (FRONT AND REAR)

+ = ADD THE STROKE

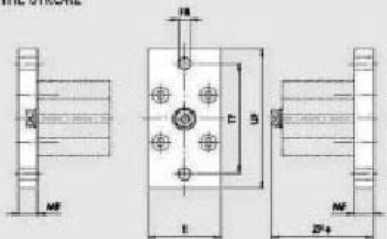

	\varnothing	E	\varnothing FB	MF	TF	LF	ZF	Weight [g]
437.02-M	20	36	6.6	10*	55	70	53*	184
437.03-M	25	40	6.6	10*	60	76	55*	226

Note: Supplied with 4 screws

* IMPORTANT: Non ISO 21287 norm fixing distance

FLANGE \varnothing 32 to 100 - MODEL C (FRONT AND REAR)

+ = ADD THE STROKE

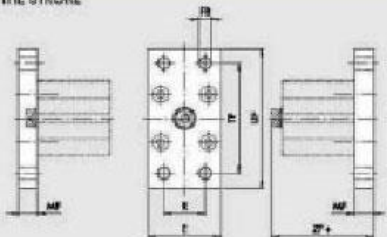
Material steel

	\varnothing	E	\varnothing FB	MF	R	TF	LF	ZF	Weight [g]
437.04-M	32	50	7	10	32	64	80	61	246
450.020-M	40	55	9	10	36	72	90	62	290
450.030-M	50	65	9	12	45	90	110	65	522
450.040-M	63	75	9	12	50	100	120	69	670
450.050-M	80	95	12	16	63	126	153	80	1420
450.060-M	100	115	14	16	75	150	178	93	2040

Note: Supplied with 4 screws

Compact cylinders LINER

Acc.to ISO 21287 Ø 20 to 100
 Type No. 7.DMI.20005 to 7.DMI.100080
 Type No. 7.DMA.20005 to 7.DMA.100080



ARTICULATED MALE HINGE - MODEL BAS

+ = ADD THE STROKE

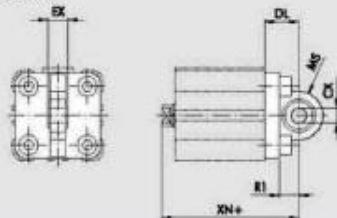

	Ø	ØCX	DL	EX	M5	R1	XN	Weight [g]
450.91-M	32	10	22	14	16	12	73	106
450.92-M	40	12	25	16	18	15	77	142
450.93-M	50	12	27	16	21	19	80	236
450.94-M	63	16	32	21	23	20	89	336
450.95-M	80	16	36	21	28	24	100	572
450.96-M	100	20	41	25	30	25	118	840

Note: Supplied with 4 screws

FLANGE FOR OPPOSITE CYLINDERS

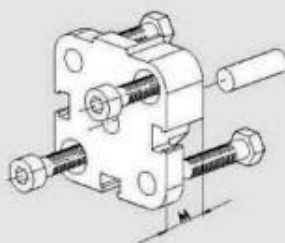

Ø	M	Weight [g]
20	12.5	45
25	13	57
32	14.5	88
40	14.5	106
50	14.5	158
63	14.5	258
80	16.5	452
100	19.5	801

Note: Supplied complete with 1 pin, 4 screws

ASSEMBLING OPPOSING CYLINDERS

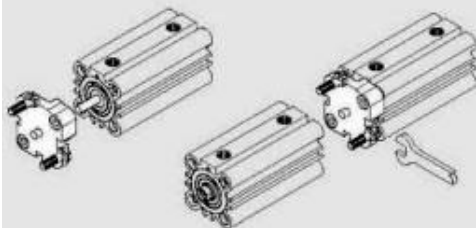

FORK - MODEL GK-M

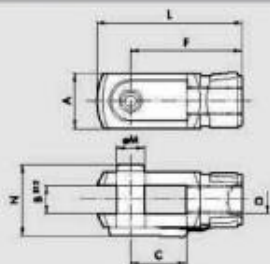

	Ø	A	B	C	D	F	L	øM	N	Weight [g]
437.32-M	20	16	8	16	M8	32	42	8	22	48
437.32-M	25	16	8	16	M8	32	42	8	22	48
450.51-M	32	20	10	20	M10x1.25	40	52	10	26	92
450.51-M	40	20	10	20	M10x1.25	40	52	10	26	92
450.52-M	50	24	12	24	M12x1.25	48	62	12	32	148
450.52-M	63	24	12	24	M12x1.25	48	62	12	32	148
450.53-M	80	32	16	32	M16x1.5	64	83	16	40	340
450.53-M	100	32	16	32	M16x1.5	64	83	16	40	340

Note: Individually packed

ROD EYE - MODEL GA-M

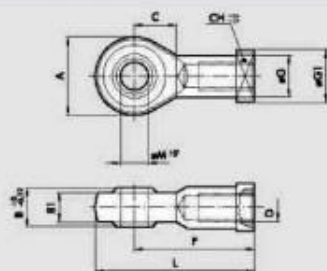

	Ø	A	B	B1	C	CH	D	F	øG	øG1	L	øM	Weight [g]
437.42-M	20	24	12	9	13	14	M8	36	12.5	16	48	8	50
437.42-M	25	24	12	9	13	14	M8	36	12.5	16	48	8	50
450.410-M	32	28	14	10.5	15	17	M10x1.25	43	15	19	57	10	78
450.410-M	40	28	14	10.5	15	17	M10x1.25	43	15	19	57	10	78
450.420-M	50	32	16	12	17	19	M12x1.25	50	17.5	22	66	12	116
450.420-M	63	32	16	12	17	19	M12x1.25	50	17.5	22	66	12	116
450.430-M	80	42	21	15	23	22	M16x1.5	64	22	27	85	16	226
450.430-M	100	42	21	15	23	22	M16x1.5	64	22	27	85	16	226

Note: Individually packed

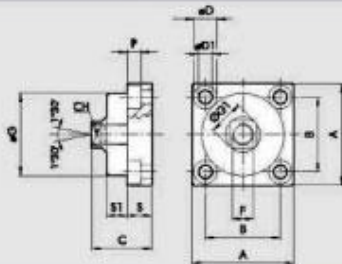
COMPENSATION JOINT - MODEL GA

Ø	A	B	C	CH	øD	øD1	F	øG	ØG1	P	S	S1	Weight [g]
32	49	36	30	13	11	6.5	M10x1.25	39.5	17	6.5	12	10	172
40	49	36	30	13	11	6.5	M10x1.25	39.5	17	6.5	12	10	172
50	59	42	36	15	14	8.5	M12x1.25	44	19	8.5	15	13.5	286
63	59	42	36	15	14	8.5	M12x1.25	44	19	8.5	15	13.5	286
80	79	58	44	22	17	10.5	M16x1.5	59	26	10.5	20	15	628
100	79	58	44	22	17	10.5	M16x1.5	59	26	10.5	20	15	628

Note: Individually packed

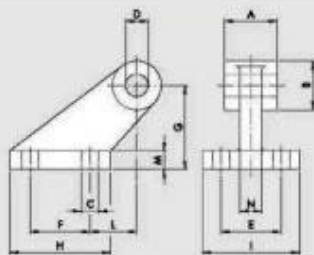
COUNTER-HINGE CETOP \varnothing 32 to 100

Material aluminium

	Ø	A	B	C	D	E	F	G	H	I	L	M	N	Weight [g]
437.23-M	32	26	19	7	10	25	20	32	37	41	18	8	10	96
437.24-M	40	28	26	9	12	32	32	45	54	52	25	10	12	216
437.25-M	50	32	26	9	12	32	32	45	54	52	25	10	12	212
437.26-M	63	40	33	11	16	40	50	63	75	63	32	12	15	440
437.27-M	80	50	33	11	16	40	50	63	75	63	32	12	15	464
450.260-M	100	60	44	14	20	50	70	90	103	80	40	16	22	985

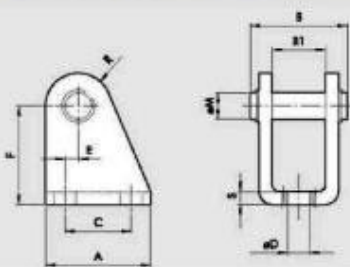
Note: Supplied complete with 4 screws

COUNTER-HINGE \varnothing 16 to 25 - MODEL BC

Ø	A	B	B1	C	øD	E	F	øM	R	S	Weight [g]
20	32	30	16	20	6.5	4	30	8	10	4	78
25	32	30	16	20	6.5	4	30	8	10	4	78

Note: Supplied complete with 1 pin and 2 snap rings

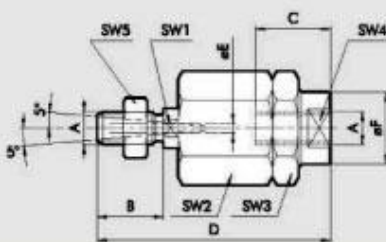
SELF ALIGNING ROD COUPLER - MODEL GA-K

	Ø	A	B	C	D	øE	øF	SW1	SW2	SW3	SW4	SW5	Weight [g]
450.100-M	20	M8	20	20	57	4	12.5	7	17	17	11	13	56
450.100-M	25	M8	20	20	57	4	12.5	7	17	17	11	13	56
450.101-M	32	M10x1.25	20	20	71	4	22	12	30	30	19	17	216
450.101-M	40	M10x1.25	20	20	71	4	22	12	30	30	19	17	216
450.102-M	50	M12x1.25	24	20	75	4	22	12	30	30	19	19	220
450.102-M	63	M12x1.25	24	20	75	4	22	12	30	30	19	19	220
450.103-M	80	M16x1.5	32	32	103	4	32	20	41	41	30	24	620
450.103-M	100	M16x1.5	32	32	103	4	32	20	41	41	30	24	620

Note: Individually packed

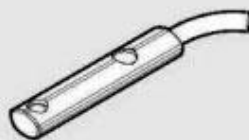
RETRACTABLE SENSOR WITH INSERTION FROM ABOVE

	Description
235.06-M	HALL N.O. sensor, vertical insertion 2.5 m
235.07-M	HALL N.O. sensor, vertical insertion 300 mm M8
235.03-M	REED N.O. sensor, vertical insertion 2.5 m
235.04-M	REED N.O. sensor, vertical insertion 300 mm M8
	HALL N.O. sensor, vertical insertion 2 m ATEX
	HALL N.O. sensor, vertical insertion HS 2.5 m
	HALL N.O. sensor, vertical insertion HS 300 mm M8
	REED N.O. sensor, vertical insertion HS 2.5 m
	REED N.O. sensor, vertical insertion HS 300 mm M8

* For use when standard sensors do not detect the magnet, e.g. near metal masses.
 NB: For technical data see page 1-312

Compact cylinders LINER

Acc.to ISO 21287 Ø 20 to 100
 Type No. 7.DMI.20005 to 7.DMI.100080
 Type No. 7.DMA.20005 to 7.DMA.100080



Piston rod nut

Type No.	Art. No.	Piston rod-Ø	Piston rod thread	Material
436.32-M	105737	20 – 25	M8	steel
436.33-M	105738	32 – 40	M10x1.25	steel
435.82-M	106166	50 – 63	M12x1.25	brass
435.83-M	106167	80 – 100	M16x1.5	brass



436.33-M

COMPACT CYLINDERS ISO 21287 (POLYURETHANE)

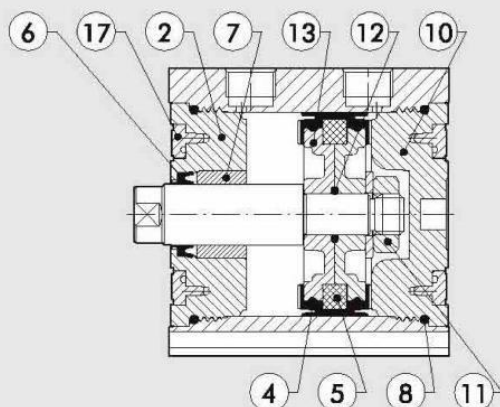

Code	Bores	Type	Parts
009...L001	Ø 20, 25	Complete set of gaskets polyurethane	④ ⑤ ⑥
009...L001	Ø 32 to 63	Complete set of gaskets polyurethane	④ ⑤ ⑥ ⑭ ⑰
009...L001	Ø 80, 100	Complete set of gaskets polyurethane	④ ⑤ ⑥ ⑭
009...L008	Ø 20, 25	Complete set of high temperature gaskets	④ ⑤ ⑥
009...L008	Ø 32 to 63	Complete set of high temperature gaskets	④ ⑤ ⑥ ⑭ ⑰
009...L008	Ø 80, 100	Complete set of high temperature gaskets	④ ⑤ ⑥ ⑭
009...L101	Ø 20, 25, 80, 100	Front head kit	② ③ ⑦ ⑧
009...L101	Ø 32 to 63	Front head kit	② ③ ⑦ ⑧ ⑰
009...L201	Ø 20, 25, 80, 100	Rear head kit	⑧ ⑱
009...L201	Ø 32 to 63	Rear head kit	⑧ ⑱ ⑰
009...7401	Ø 20, 25	Piston kit polyurethane	④ ⑤ ⑪
009...L401	Ø 32 to 63	Piston kit polyurethane	④ ⑤ ⑪ ⑫ ⑬ ⑰
009...7401	Ø 80 to 100	Piston kit polyurethane	④ ⑤ ⑪ ⑫ ⑬
009...7501	Ø 20, 25, 80, 100	Magnet	⑤
009...L501	Ø 32 to 63	Magnet	⑤ ⑰
009...L901	Ø 20, 25	Front + rear cylinder head + piston kit polyurethane	② ④ ⑤ ⑥ ⑦ ⑧ ⑱ ⑲
009...L901	Ø 32 to 63	Front + rear cylinder head + piston kit polyurethane	② ④ ⑤ ⑥ ⑦ ⑧ ⑱ ⑲ ⑲ ⑲
009...L901	Ø 80, 100	Front + rear cylinder head + piston kit polyurethane	② ④ ⑤ ⑥ ⑦ ⑧ ⑱ ⑲ ⑲

Cylinder bore D mm	Piston rod diameter d mm	Motion	Useful area cm ²	Thrust and traction force in daN depending on the operating pressure in bar									
				1 bar	2 bar	3 bar	4 bar	5 bar	6 bar	7 bar	8 bar	9 bar	10 bar
20	10	thrust	3.14	3.1	6.3	9.4	12.6	15.7	18.8	22.0	25.1	28.3	31.4
		traction	2.36	2.4	4.7	7.1	9.4	11.8	14.1	16.5	18.8	21.2	23.6
25	8	thrust	4.91	4.9	9.8	14.7	19.6	24.5	29.5	34.4	39.3	44.2	49.1
		traction	4.41	4.4	8.8	13.2	17.6	22.0	26.4	30.8	35.2	39.7	44.1
25	10	thrust	4.91	4.9	9.8	14.7	19.6	24.5	29.5	34.4	39.3	44.2	49.1
		traction	4.12	4.1	8.2	12.4	16.5	20.6	24.7	28.9	33.0	37.1	41.2
32	12	thrust	8.04	8.0	16.1	24.1	32.2	40.2	48.3	56.3	64.3	72.4	80.4
		traction	6.91	6.9	13.8	20.7	27.6	34.6	41.5	48.4	55.3	62.2	69.1
40	12	thrust	12.57	12.6	25.1	37.7	50.3	62.8	75.4	88.0	100.5	113.1	125.7
		traction	11.44	11.4	22.9	34.3	45.7	57.2	68.6	80.0	91.5	102.9	114.4
40	16	thrust	12.57	12.6	25.1	37.7	50.3	62.8	75.4	88.0	100.5	113.1	125.7
		traction	10.56	10.6	21.1	31.7	42.2	52.8	63.3	73.9	84.4	95.0	105.6
50	16	thrust	19.63	19.6	39.3	58.9	78.5	98.2	117.8	137.4	157.1	176.7	196.3
		traction	17.62	17.6	35.2	52.9	70.5	88.1	105.7	123.4	141.0	158.6	176.2
50	20	thrust	19.63	19.6	39.3	58.9	78.5	98.2	117.8	137.4	157.1	176.7	196.3
		traction	16.49	16.5	33.0	49.5	66.0	82.5	99.0	115.5	131.9	148.4	164.9
63	16	thrust	31.17	31.2	62.3	93.5	124.7	155.9	187.0	218.2	249.4	280.6	311.7
		traction	29.16	29.2	58.3	87.5	116.6	145.8	175.0	204.1	233.3	262.5	291.6
63	20	thrust	31.17	31.2	62.3	93.5	124.7	155.9	187.0	218.2	249.4	280.6	311.7
		traction	28.03	28.0	56.1	84.1	112.1	140.2	168.2	196.2	224.2	252.3	280.3
80	20	thrust	50.27	50.3	100.5	150.8	201.1	251.3	301.6	351.9	402.1	452.4	502.7
		traction	47.12	47.1	94.2	141.4	188.5	235.6	282.7	329.9	377.0	424.1	471.2
80	25	thrust	50.27	50.3	100.5	150.8	201.1	251.3	301.6	351.9	402.1	452.4	502.7
		traction	45.36	45.4	90.7	136.1	181.4	226.8	272.1	317.5	362.9	408.2	453.6
100	25	thrust	78.54	78.5	157.1	235.6	314.2	392.7	471.2	549.8	628.3	706.9	785.4
		traction	73.63	73.6	147.3	220.9	294.5	368.2	441.8	515.4	589.0	662.7	736.3
125	32	thrust	122.72	122.7	245.4	368.2	490.9	613.6	736.3	859.0	981.7	1104.5	1227.2
		traction	114.68	114.7	229.4	344.0	458.7	573.4	688.1	802.7	917.4	1032.1	1146.8
160	40	thrust	201.06	201.1	402.1	603.2	804.2	1005.3	1206.4	1407.4	1608.5	1809.6	2010.6
		traction	188.50	188.5	377.0	565.5	754.0	942.5	1131.0	1319.5	1508.0	1696.5	1885.0
200	40	thrust	314.16	314.2	628.3	942.5	1256.6	1570.8	1885.0	2199.1	2513.3	2827.4	3141.6
		traction	301.59	301.6	603.2	904.8	1206.4	1508.0	1809.6	2111.1	2412.7	2714.3	3015.9

ISO 21287 cylinder series LINER				
Ø	Single-rod		Through-rod	
	Weight [g] Stroke = 0	Weight [g] each mm	Weight [g] Stroke = 0	Weight [g] each mm
20	98	2.49	110	3.10
25	119	2.63	133	3.24
32	182	3.62	197	4.50
40	228	4.09	243	4.98
50	330	5.67	355	7.25
63	461	6.52	487	8.10
80	991	10.11	1066	12.58
100	1869	13.78	2029	17.63

Compact cylinders LINER

Acc.to ISO 21287 Ø 20 to 100

Type No. 7.DMI.20005 to 7.DMI.100080

Type No. 7.DMA.20005 to 7.DMA.100080



Ordering information

Artikel Nr.	Ident Nr.
7.DMI.20005	105967
7.DMI.20010	105968
7.DMI.20015	105969
7.DMI.20020	105970
7.DMI.20025	105971
7.DMI.20030	105972
7.DMI.20040	105973
7.DMI.20050	105974
7.DMI.20060	105975
7.DMI.25005	105976
7.DMI.25010	105977
7.DMI.25015	105978
7.DMI.25020	105979
7.DMI.25025	105980
7.DMI.25030	105981
7.DMI.25040	105982
7.DMI.25050	105983
7.DMI.25060	105984
7.DMI.32005	105985
7.DMI.32010	105986
7.DMI.32015	105987
7.DMI.32020	105988
7.DMI.32025	105989
7.DMI.32030	105990
7.DMI.32040	105991
7.DMI.32050	105992
7.DMI.32060	105993
7.DMI.32080	105994
7.DMI.40005	105995
7.DMI.40010	105996
7.DMI.40015	105997
7.DMI.40020	105998
7.DMI.40025	105999
7.DMI.40030	106000
7.DMI.40040	106001
7.DMI.40050	106002
7.DMI.40060	106003
7.DMI.40080	106004
7.DMI.50005	106005
7.DMI.50010	106006
7.DMI.50015	106007
7.DMI.50020	106008
7.DMI.50025	106009
7.DMI.50030	106010
7.DMI.50040	106011
7.DMI.50050	106012
7.DMI.50060	106013
7.DMI.50080	106014
7.DMI.63005	106015
7.DMI.63010	106016

Artikel Nr.	Ident Nr.
7.DMI.63015	106017
7.DMI.63020	106018
7.DMI.63025	106019
7.DMI.63030	106020
7.DMI.63040	106021
7.DMI.63050	106022
7.DMI.63060	106023
7.DMI.63080	106024
7.DMI.80005	106025
7.DMI.80010	106026
7.DMI.80015	106027
7.DMI.80020	106028
7.DMI.80025	106029
7.DMI.80030	106030
7.DMI.80040	106031
7.DMI.80050	106032
7.DMI.80060	106033
7.DMI.80080	106034
7.DMI.100005	106035
7.DMI.100010	106036
7.DMI.100015	106037
7.DMI.100020	106038
7.DMI.100025	106039
7.DMI.100030	106040
7.DMI.100040	106041
7.DMI.100050	106042
7.DMI.100060	106043
7.DMI.100080	106044
7.DMA.20005	106045
7.DMA.20010	106046
7.DMA.20015	106047
7.DMA.20020	106048
7.DMA.20025	106049
7.DMA.20030	106050
7.DMA.20040	106051
7.DMA.20050	106052
7.DMA.20060	106053
7.DMA.25005	106054
7.DMA.25010	106055
7.DMA.25015	106056
7.DMA.25020	106057
7.DMA.25025	106058
7.DMA.25030	106059
7.DMA.25040	106060
7.DMA.25050	106061
7.DMA.25060	106062
7.DMA.32005	106063
7.DMA.32010	106064
7.DMA.32015	106065
7.DMA.32020	106066
7.DMA.32025	106067
7.DMA.32030	106068

Compact cylinders LINER

Acc.to ISO 21287 Ø 20 to 100

Type No. 7.DMI.20005 to 7.DMI.100080

Type No. 7.DMA.20005 to 7.DMA.100080



Artikel Nr.	Ident Nr.
7.DMA.32040	106069
7.DMA.32050	106070
7.DMA.32060	106071
7.DMA.32080	106072
7.DMA.40005	106073
7.DMA.40010	106074
7.DMA.40015	106075
7.DMA.40020	106076
7.DMA.40025	106077
7.DMA.40030	106078
7.DMA.40040	106079
7.DMA.40050	106080
7.DMA.40060	106081
7.DMA.40080	106082
7.DMA.50005	106083
7.DMA.50010	106084
7.DMA.50015	106085
7.DMA.50020	106086
7.DMA.50025	106087
7.DMA.50030	106088
7.DMA.50040	106089
7.DMA.50050	106090
7.DMA.50060	106091
7.DMA.50080	106092
7.DMA.63005	106093
7.DMA.63010	106094
7.DMA.63015	106095
7.DMA.63020	106096
7.DMA.63025	106097
7.DMA.63030	106098
7.DMA.63040	106099
7.DMA.63050	106100
7.DMA.63060	106101
7.DMA.63080	106102
7.DMA.80005	106103
7.DMA.80010	106104
7.DMA.80015	106105
7.DMA.80020	106106
7.DMA.80025	106107
7.DMA.80030	106108
7.DMA.80040	106109
7.DMA.80050	106110
7.DMA.80060	106111
7.DMA.80080	106112
7.DMA.100005	106113
7.DMA.100010	106114
7.DMA.100015	106115
7.DMA.100020	106116
7.DMA.100025	106117
7.DMA.100030	106118
7.DMA.100040	106119
7.DMA.100050	106120

Artikel Nr.	Ident Nr.
7.DMA.100060	106121
7.DMA.100080	106122
437.09-M	106123
437.10-M	106124
437.14-M	106125
450.12-M	106126
450.13-M	106127
450.14-M	106128
450.15-M	106129
450.16-M	106130
437.84-M	106131
437.85-M	106132
437.86-M	106133
437.87-M	106134
437.88-M	106135
450.36-M	106136
437.23-M	106137
437.24-M	106138
437.25-M	106139
437.26-M	106140
437.27-M	106141
450.260-M	106142
437.72-M	106143
437.73-M	106144
450.71-M	106145
450.72-M	106146
450.73-M	106147
450.74-M	106148
450.75-M	106149
450.76-M	106150
450.91-M	106151
450.92-M	106152
450.93-M	106153
450.94-M	106154
450.95-M	106155
450.96-M	106156
437.02-M	106157
437.03-M	106158
437.04-M	106159
450.020-M	106160
450.030-M	106161
450.040-M	106162
450.050-M	106163
450.060-M	106164
437.32-M	105740
450.51-M	105741
450.52-M	105886
450.53-M	105887
437.42-M	105743
450.410-M	105744
450.420-M	105888
450.430-M	105889

Compact cylinders LINER

Acc.to ISO 21287 Ø 20 to 100
Type No. 7.DMI.20005 to 7.DMI.100080
Type No. 7.DMA.20005 to 7.DMA.100080



Artikel Nr.	Ident Nr.
450.100-M	106165
450.101-M	105890
450.102-M	105891
450.103-M	105892
436.32-M	105737
436.33-M	105738
435.82-M	106166
435.83-M	106167
235.03-M	105748
235.04-M	105749
235.06-M	105750
235.07-M	105751
235.11-M	106168
235.12-M	106169
235.15-M	106170
235.16-M	106171
235.17-M	106172
235.18-M	106173
235.19-M	106174
235.20-M	106175
235.21-M	106176
235.22-M	106177